

CE Electronics

**La Gamme
Supplémentaire
d'Indicateurs
pour**

OTIS

OTIS

Otis Elevator Company

Newberry Road

Bloomfield, CT

Ph: 860.676.6000

Otis Worldwide

www.otisworldwide.com



ELECTRONICS

Interfaces série d'Otis

MOTIS 401 Remote Station Interface au Microcomm

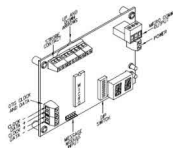

Serial Link
Clock/Data
110VAC
-24/30VDC

OCDL 411 Serial Link Interface au Microcomm

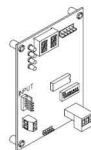

OEMS 411 Serial Link Interface au Microcomm et EMS RS485 interface

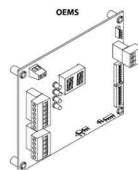

Voix

OV401 tableau indicateur des appels jusqu'à 80 messages

OV411 tableau indicateur des appels jusqu'à 80 messages



Otis 2000 LCD

OB215-W 50mm Caractère blanc sur le bleu



OL215-X 50mm Caractère R,V,B,J sur le noir



Otis Montages De Luxe

Serial Link
Clock/Data
110VAC
-24/30VDC

OLAD-S

75mm flèche bicolore de LED + 56mm LED 16 segment + barre latérale + gong (vertical)

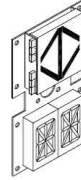

OLHAD-S

75mm flèche bicolore de LED + 56mm LED 16 segment + barre latérale + gong (horizontale)

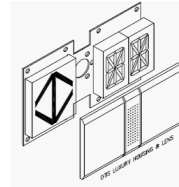

OLHD-XV3

75mm Flèches bicolore de LED + barre latérale + gong (verticale)

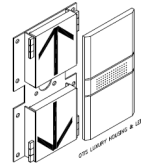

OLHD-XHX

75mm flèches bicolore de LED + gong (horizontale)

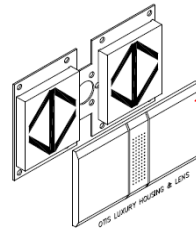

OLHS-XX

75mm flèche bicolore de LED + barre latérale + gong

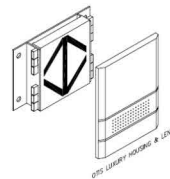

Montages Avancés Otis

Serial Link
Clock/Data
110VAC
-24/30VDC

OAHE 75mm flèche bicolore de LED + barre latérale + gong

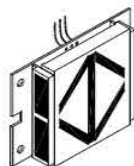

OAHF 75mm flèche bicolore de LED + Gong

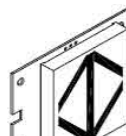

OHCTS 50mm LED 16 segment + gong (horizontale montré)

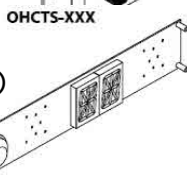

OVCTS version verticale

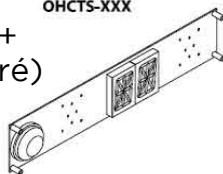

Galets d'Hockey Otis

Remplacez l'ampoule et les cloches mécaniques par la LED à semi-conducteur et le gong électronique

OHP-X1 par le mur

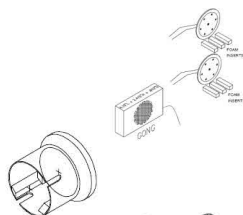

OHP-X2 métal appliqué

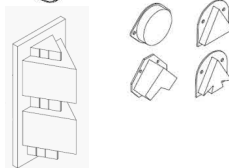

OHP-XWD cale

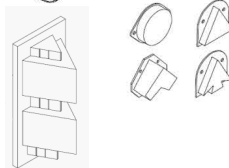







Montages Sur Mesure

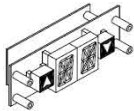

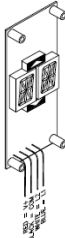

Lanternes palières spéciales, indicateurs de champ et logements d'indicateur tout manufacturés selon les caractéristiques de l'architecte dans une gamme des matériaux comprenant l'acier, verre, perspex, en céramique et en bois.



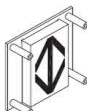

indicateurs 16 Segment

			Serial Link Clock/Data 110VAC -24/30VDC
OE205	2 caractère 12mm LED + flèches		<input checked="" type="checkbox"/> <input type="checkbox"/> <input type="checkbox"/> <input type="checkbox"/>
OH210	2 caractère 30mm LED + flèches		<input checked="" type="checkbox"/> <input type="checkbox"/> <input type="checkbox"/> <input type="checkbox"/>
OS222	2 caractère 56mm LED + flèches		<input checked="" type="checkbox"/> <input type="checkbox"/> <input type="checkbox"/> <input type="checkbox"/>
OSV21	2 caractère 30mm LED + flèches		<input checked="" type="checkbox"/> <input type="checkbox"/> <input type="checkbox"/> <input type="checkbox"/>
OV105	2 caractère 12mm LED + flèches		<input checked="" type="checkbox"/> <input type="checkbox"/> <input type="checkbox"/> <input type="checkbox"/>
LO220 OV220	2 caractère 50mm LED		<input type="checkbox"/> <input checked="" type="checkbox"/> <input type="checkbox"/> <input type="checkbox"/> <input checked="" type="checkbox"/> <input type="checkbox"/> <input type="checkbox"/> <input type="checkbox"/>
VO212 OVF12	2 caractère 30mm vide fleurissant		<input type="checkbox"/> <input checked="" type="checkbox"/> <input type="checkbox"/> <input type="checkbox"/> <input checked="" type="checkbox"/> <input type="checkbox"/> <input type="checkbox"/> <input type="checkbox"/>

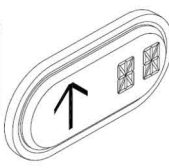

Lanterns Série

OH125	63mm flèche bicolore de LED + gong (horizontale montrée)		<input checked="" type="checkbox"/> <input type="checkbox"/> <input type="checkbox"/> <input type="checkbox"/>
OV125	version verticale		<input checked="" type="checkbox"/> <input type="checkbox"/> <input type="checkbox"/> <input type="checkbox"/>
SA130-HOS	75mm flèche bicolore de LED + gong (horizontale)		<input checked="" type="checkbox"/> <input type="checkbox"/> <input type="checkbox"/> <input type="checkbox"/>
SA130-VOS	version verticale montrée		<input checked="" type="checkbox"/> <input type="checkbox"/> <input type="checkbox"/> <input type="checkbox"/>
SNAPINOCG	75mm flèche bicolore de		<input type="checkbox"/> <input type="checkbox"/> <input checked="" type="checkbox"/> <input type="checkbox"/>
SNAPINOFG	LED + gong		<input type="checkbox"/> <input type="checkbox"/> <input type="checkbox"/> <input checked="" type="checkbox"/>
SNAPINOSG			<input checked="" type="checkbox"/> <input type="checkbox"/> <input type="checkbox"/> <input type="checkbox"/>

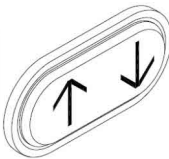
Indicateurs Classiques

GTCV-OS	75mm flèche bicolore + 56mm LED 16 segment + gong (verticale)			Serial Link Clock/Data 110VAC -24/30VDC	<input checked="" type="checkbox"/> <input type="checkbox"/> <input type="checkbox"/> <input type="checkbox"/>
GTCH-OS	Version horizontale				<input checked="" type="checkbox"/> <input type="checkbox"/> <input type="checkbox"/> <input type="checkbox"/>
GTDV-OS	75mm flèche bicolore + gong (verticale)				<input checked="" type="checkbox"/> <input type="checkbox"/> <input type="checkbox"/> <input type="checkbox"/>
GTDH-OS	Version horizontale				<input checked="" type="checkbox"/> <input type="checkbox"/> <input type="checkbox"/> <input type="checkbox"/>

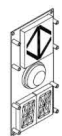
Série Spectra

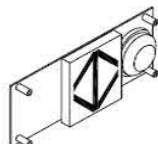

OVETC	75mm flèche bicolore + 56mm LED Display + Gong + barres latérales facultatives (verticale)				<input checked="" type="checkbox"/> <input type="checkbox"/> <input type="checkbox"/> <input type="checkbox"/>
OHETC	Version horizontale				<input checked="" type="checkbox"/> <input type="checkbox"/> <input type="checkbox"/> <input type="checkbox"/>
OH911	75mm flèche bicolore + gong (horizontale montrée)				<input checked="" type="checkbox"/> <input type="checkbox"/> <input type="checkbox"/> <input type="checkbox"/>
OV911	version verticale avec barres latérales				<input checked="" type="checkbox"/> <input type="checkbox"/> <input type="checkbox"/> <input type="checkbox"/>

Destination

ODBA10	indicateur à deux chiffres de la destination dix				<input checked="" type="checkbox"/> <input type="checkbox"/> <input type="checkbox"/> <input type="checkbox"/>
OFLAG	67mm LED indicateur d'arrivée prolongé				<input checked="" type="checkbox"/> <input type="checkbox"/> <input type="checkbox"/> <input type="checkbox"/>
OPENDANT	67mm LED indicateur d'arrivée				<input checked="" type="checkbox"/> <input type="checkbox"/> <input type="checkbox"/> <input type="checkbox"/>
OBOX	67mm LED indicateur d'arrivée				<input checked="" type="checkbox"/> <input type="checkbox"/> <input type="checkbox"/> <input type="checkbox"/>

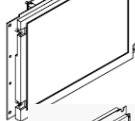
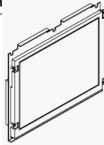
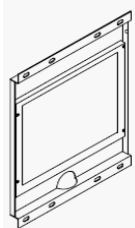
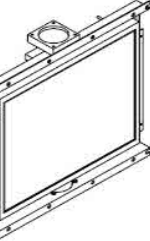

TFT Flat Panel LCD

Serial Link
Clock/Data
110VAC
-24/30VDC

OELDX-B	10.4" ELD polychrome		<input checked="" type="checkbox"/> <input checked="" type="checkbox"/> <input type="checkbox"/> <input type="checkbox"/>
OCX10-B	8.4" indicateur de position TFT (montrée)		<input checked="" type="checkbox"/> <input checked="" type="checkbox"/> <input type="checkbox"/> <input type="checkbox"/>
OHX10-A	8.4" indicateur de position TFT		<input checked="" type="checkbox"/> <input checked="" type="checkbox"/> <input type="checkbox"/> <input type="checkbox"/>
OX104-A	10.4" indicateur de position TFT (montrée)		<input checked="" type="checkbox"/> <input checked="" type="checkbox"/> <input type="checkbox"/> <input type="checkbox"/>
OX104-B	version étroite de support		<input checked="" type="checkbox"/> <input checked="" type="checkbox"/> <input type="checkbox"/> <input type="checkbox"/>
OX150-X	15" indicateur de position TFT		<input checked="" type="checkbox"/> <input checked="" type="checkbox"/> <input type="checkbox"/> <input type="checkbox"/>

Ces produits exigent une interface de Microcomm - voir la page 2

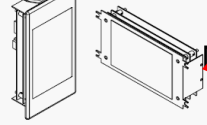
Mini TFT Flat Panel LCD

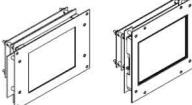
OMN43-X	4.3" indicateur de position TFT		<input checked="" type="checkbox"/> <input type="checkbox"/> <input type="checkbox"/> <input type="checkbox"/>
OMN57-AMX	5.7" indicateur de position TFT	 	<input checked="" type="checkbox"/> <input type="checkbox"/> <input type="checkbox"/> <input type="checkbox"/>



INDICATORS

16 Segment - Dot Matrix
LCD Position Indicators
Scrolling Messages
Flashing Side Arrows/Bars



TFT DISPLAYS

Elite PI Elevator Displays
8.4" 10.4" 15" 19"
5.7" Mini Destination TFT Displays
Floor Information & Scheduled Messages
Video/TV/Live Data
Customised Layout
ADA/DDA Compliant
Very Wide Viewing Angle
Full Colour Display



VINTAGE SWEEP

Antique, Contemporary and Unique Designs
Smooth and Steady Arrow Indicator flow
180° & 360° Position Indicators



SECURITY

Keypad/Swipecard/Fob/Proximity Readers
Secure up to 32 Landings
Up to 600 Different Access Codes
6 Digit Security Code Access to Multiple Floors
7 Day and 365 Day Timer Override Options



DDA KITS

Compliant with EN81-70
Indicators/Speech Units/Gongs
Induction Loop Kits
Call Registration Buzzer
No Entry Indicator



**Le camion
d'exposition
contenant plu-
sieurs de nos
produits voy-
age toujours
l'Europe.**

**Appel +44
7909 667241
pour réserver
une visite**



Rev_3_2fr

OTIS

Otis Elevator Company | Newberry Road | Bloomfield, CT | Ph: 860.676.6000 | www.otisworldwide.com



C.E. Electronics Ltd.

C.E. Electronics Inc.

Marlow, Bucks, UK | Ph: +44 (0) 1628 487633 | www.cееlectronics.com | Bryan, OH, USA | Ph: (419) 636-6705